

# Performance Installs

## CX5-3-289 Lowering Springs

Installation Instructions for the CorkSport Performance Lowering Springs for the 2019+ Mazda CX-5 2.5L Turbo.

Written By: Barrett Strecker



## INTRODUCTION

In this installation guide we have provided step by step instructions to remove the OEM front and rear springs and install the CorkSport Performance Lowering Springs.

### Advisory:

- Working under the vehicle requires a safe and sturdy location for the vehicle to sit on jackstands.
- Spring compressors can be dangerous. Follow the manufacturer's instructions and safety precautions to prevent injury.

### TOOLS:

- Hydraulic Jack (1)
- Jack Stand (2)
- Spring Compressors (2)
- 3/8" Drive Ratchet (1)
- 1/2" Drive Breaker Bar (1)
- 1/2" Torque Wrench (1)
- 1/2" Impact Gun (if available) (1)
- 14mm Socket - Deep (1)
- 17mm Socket - Deep (1)
- 19mm Socket - Deep (1)
- 21mm Socket - Deep (1)
- 23mm Socket (1)
- 5mm Allen Key Socket (1)
- 6mm Allen Key Socket (1)
- 12mm Wrench (1)
- 14mm Wrench (1)
- 17mm Wrench (1)
- 21mm Wrench (1)
- Small Needle Nose Pliers (1)
- Vice Grip Pliers (1)
- Flathead Screwdriver (1)
- Razor Knife (1)
- Dead Blow Hammer (1)
- Pointed Pry Bar (1)

### PARTS:

- CX5-3-289-21 Front Lowering Spring (2)
- CX5-3-289-22 Rear Lowering Spring (2)

## Step 1 — Getting Started



- First and foremost; **THANK YOU** for becoming a part of the CorkSport Family. We hope to bring you the highest level of Parts, Customer Service, & Support



### How To Use These Instructions

- The instruction format will relate colored marking in the image to the color dot in the text to the right of the image

-  The lowering springs used for these install instructions were prototype springs that were powdercoated black. They are identical to your blue springs!

## Step 2 — Lifting the Car & Removing the Front Wheel



-  Ensure the vehicle is parked on a level surface before proceeding.
- Start by lifting up the front of the car using the hydraulic jack and jack stands.
-  Be sure to reference your owners manual for jack points and the jack manufacturer's instructions for proper practices.
- Remove the left side front wheel from the vehicle using the 1/2" drive breaker bar or impact gun and 21mm socket.
-  A different socket may be required if you have aftermarket or locking lug nuts.

### Step 3 — Front Suspension Component Identification

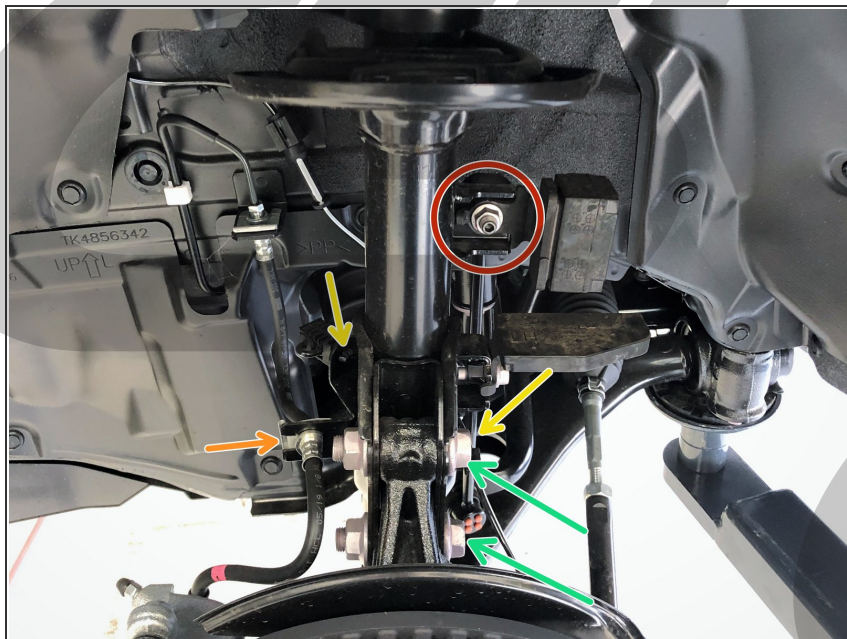

- This image serves as a location reference for components referenced in the following steps.
- Front swaybar endlink.
- Front brake line.
- ABS wiring.
- Strut lower mounting bolts.

### Step 4 — Front Suspension Disassembly Part 1

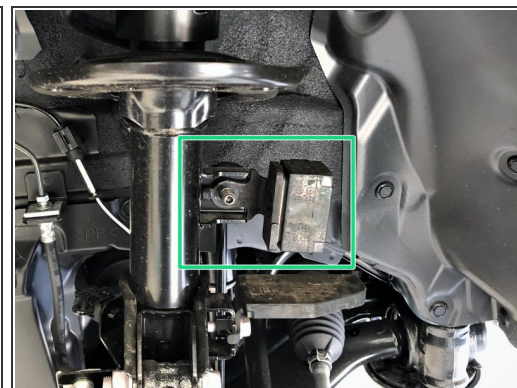
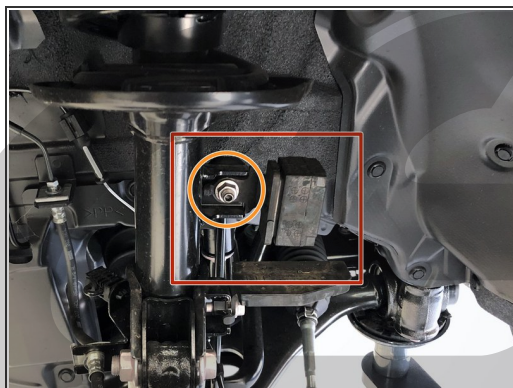

- Locate the front sway bar end link.
- Using a 14mm socket and ratchet, remove the front swaybar end link nut.
- If the nut is spinning without loosening, use a 5mm Allen key in the center to keep it secure and a 14mm wrench to loosen.
- Then remove the rubber noise isolator.

## Step 5 — Front Suspension Disassembly Part 2

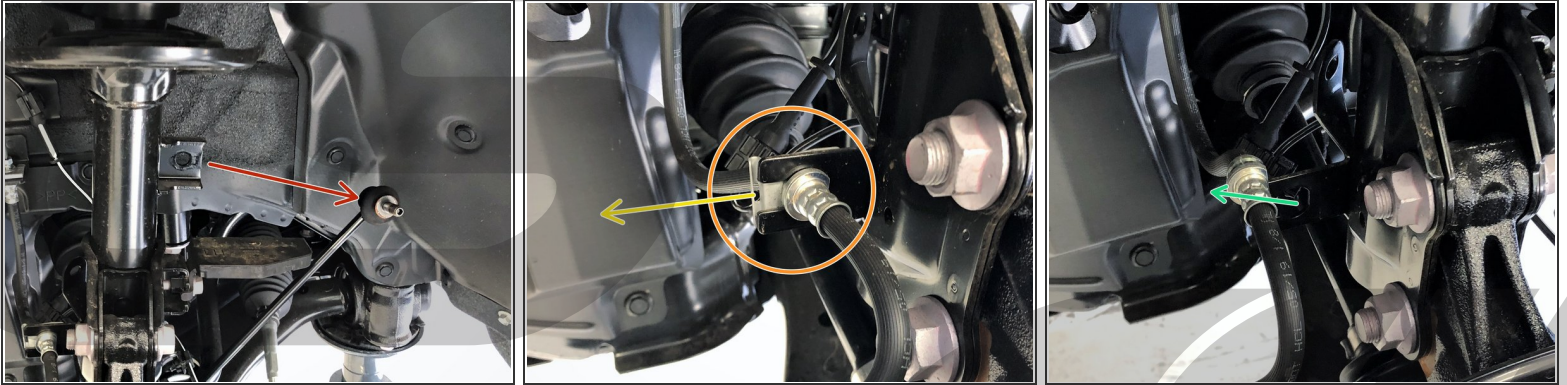

- Push the front swaybar endlink out of the mounting point on the strut and out of the way.
- Locate the front brake line.
- Using needle nose pliers or flathead screwdriver, remove the silver brake line retainer clip.
- Then free the front brake line from the strut mount.

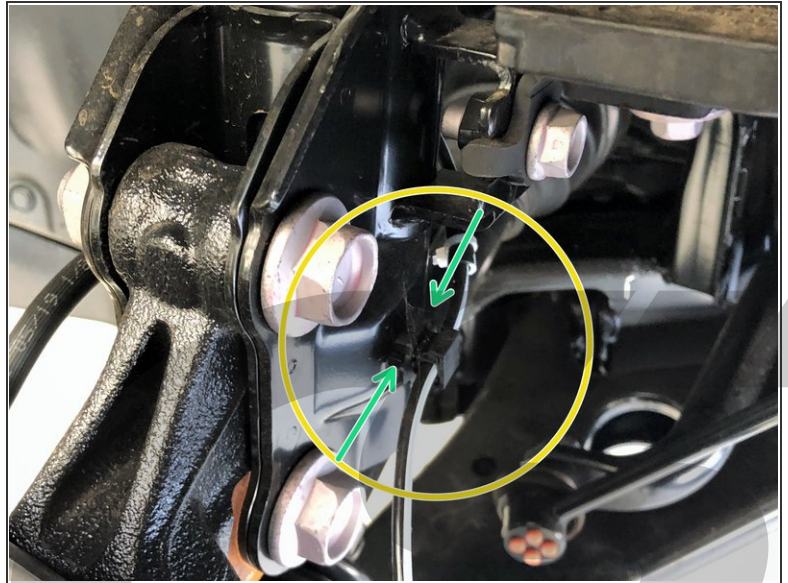
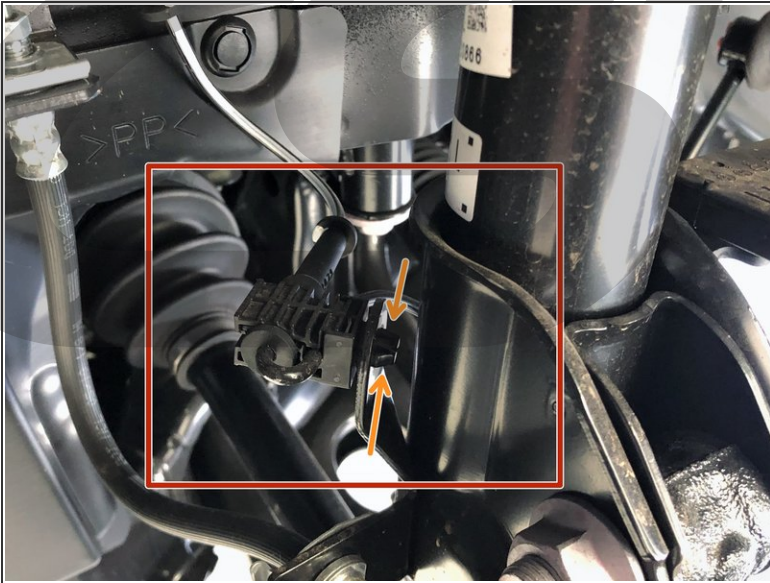
**Step 6 — Front Suspension Disassembly Part 3**

- Locate the forward section of ABS wiring.
- Using needle nose pliers, pinch the plastic clip and free the wiring from the strut mount.
- Locate the rearward section of ABS wiring.
- Using needle nose pliers, pinch the plastic clip and free the wiring from the strut mount.

## Step 7 — Front Suspension Disassembly Part 4

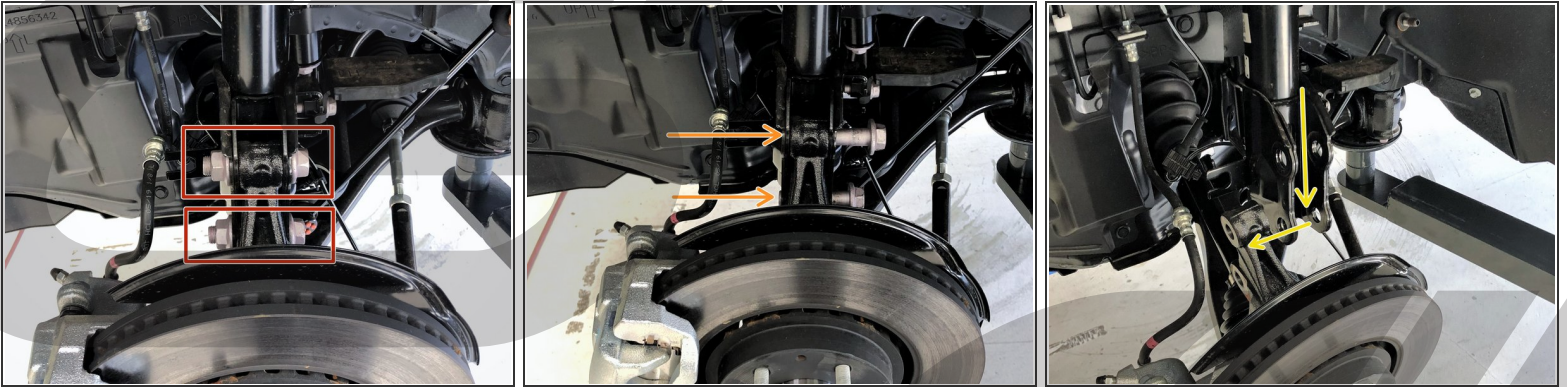

- Using a 21mm wrench and 23mm socket with a breaker bar or impact, loosen the lower strut mounting bolts.
- ⚠ Take care to not damage other components on the vehicle when loosening these bolts as they are very tight.
- Remove the nuts and then the bolts from the vehicle. One bolt shown removed.
- Free the knuckle from the front strut. It should come free with little force.
- ⓘ The lower portion of the strut can be moved around to help free the knuckle.



## Step 8 — Front Suspension Disassembly Part 5

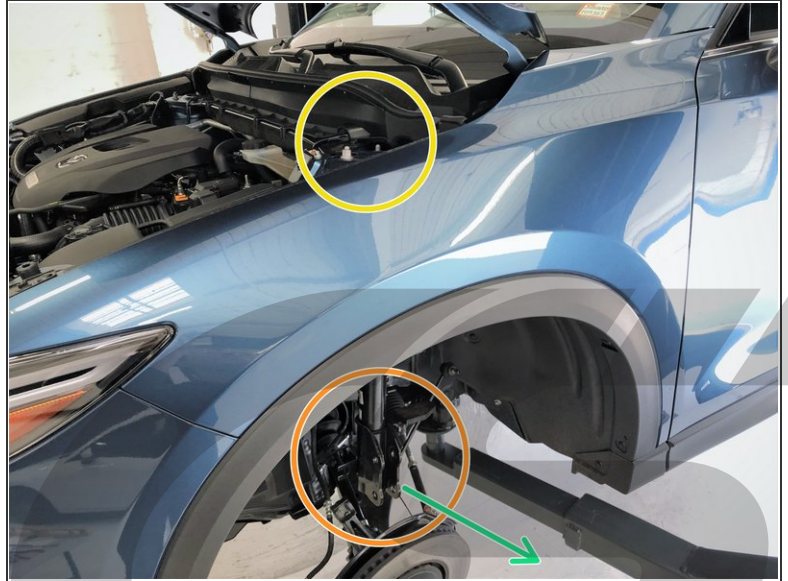

- Open the hood of your vehicle.
- Locate the three nuts holding the front strut to your vehicle. They will be near the back corner of the engine bay.
- Loosen these three nuts with a 14mm socket and ratchet.
- Hold the bottom of the strut with one hand so it does not fall during the next step.
- Completely remove the nuts with the other hand.
- Remove the front strut from the vehicle.

## Step 9 — Front Strut Disassembly Part 1



- Remove the black plastic cap from the top of the strut. It should pull straight off.
  - Ready your spring compressors. The second image shows a standalone unit that makes compressing springs easier if done frequently.
  - The third image shows more traditional spring compressors.
- ⚠ Spring compressors can be very dangerous if used improperly. Ensure you understand how to use them and are following the manufacturer's recommended practices.

## Step 10 — Front Strut Disassembly Part 2



- Compress the spring until the top spring coil is no longer touching the spring top hat.
  - Remove the 19mm nut on top of the strut using a 19mm wrench and a 6mm Allen key or socket.
- ⓘ If you have an impact gun, you can also use it to remove the strut top nut. Be sure to turn your air pressure down to 60-80psi to prevent damage to the strut.

### Step 11 — Front Strut Disassembly Part 3



- Remove the spring top hat from the front strut.
- Slowly decompress the OEM front spring.
- Remove the spring from the strut.

### Step 12 — Front Strut Disassembly Part 4

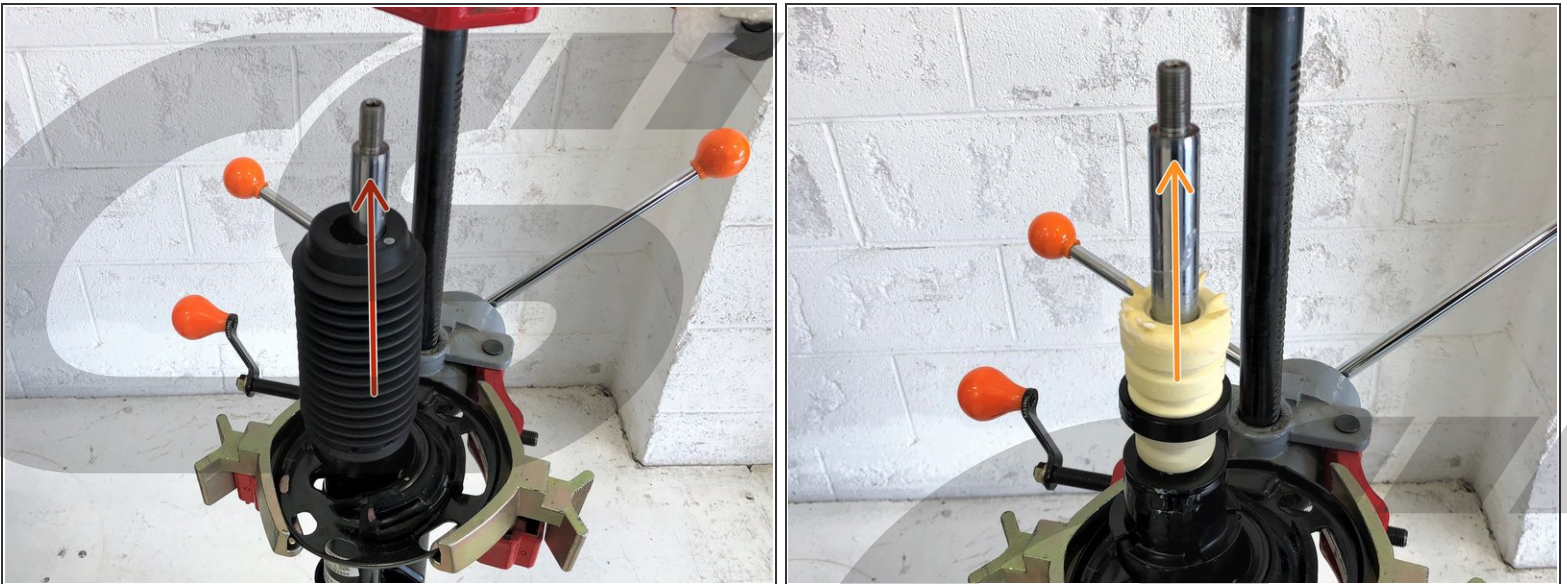

- Remove the dust boot from the front strut.
- Remove the bump stop from the front strut.

## Step 13 — Cutting the Front Bump Stop

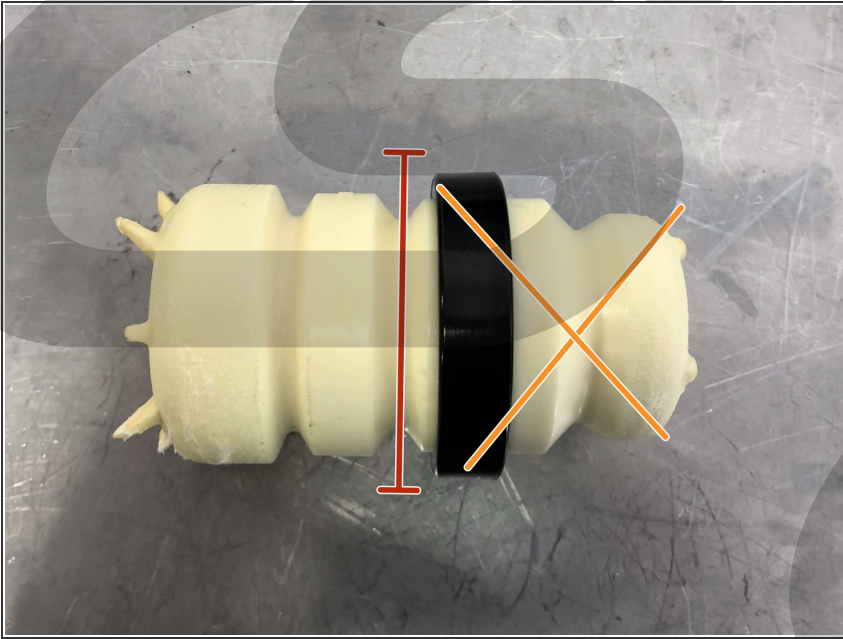

- ① In order to deliver the best ride quality, the bump stop must be trimmed. This ensures the same amount of travel before the bump stop is hit at the lower ride height.
- Mark a line all the way around the bump stop in the center of the indentation above the black ring.
- Cut the bump stop along this line.
- Discard the lower section with the black ring.
- ① After cutting, the bump stop should be about 40mm in length.

## Step 14 — Front Strut Reassembly Part 1

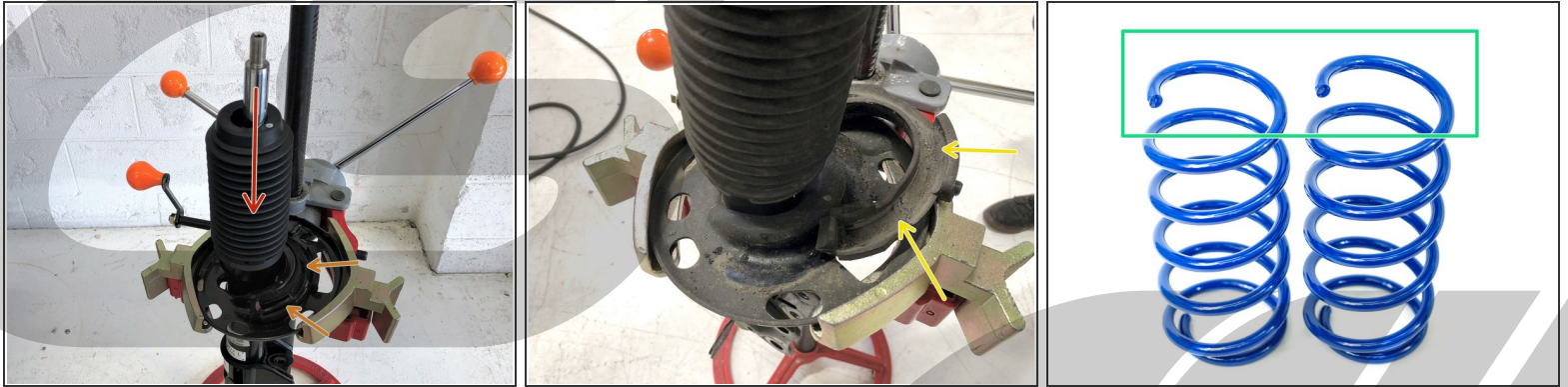

- Reinstall the trimmed bump stop onto the front strut. Ensure the smaller end points downward. Then reinstall the dust boot.
- Ensure the lower spring seat is located correctly. It can shift when the spring is removed.
  - The first image shows the lower spring seat **correctly** located.
  - The second image shows the lower spring seat **incorrectly** located.
- Identify the bottom of the CorkSport front lowering spring.
  - The bottom is the larger diameter end that is not flat.
- ⚠ There is a sticker labeling the spring for use at CS. These stickers are sometimes placed upside-down. Do not use this sticker to orient the spring.
- ℹ If desired, the stickers can be removed with the help of some brake parts cleaner or acetone.

## Step 15 — Front Strut Reassembly Part 2



- Position the spring onto the front strut. Ensure it is fully seated on the lower spring seat.
- The first image shows the spring not seated all the way.
- The second image shows the spring fully seated.
- Swap the gray OEM spring silencer onto the top of the CorkSport lowering spring.

## Step 16 — Front Strut Reassembly Part 3



- Using spring compressors, compress the CorkSport spring until the spring top hat can be installed.
- Install the spring top hat.
- Secure the spring top hat with the 19mm nut removed in step 10.
- Tighten to **41-47ft-lbs.** using the method shown in Step 10.
- ⓘ If tightening with an impact gun, ensure the pressure is turned down to about 60-80psi to prevent damage to the strut.
- Decompress the spring and remove the spring compressors.
- Check that the top coil of the spring is centered on the top hat and touching all around.

## Step 17 — Front Strut Reassembly Part 4

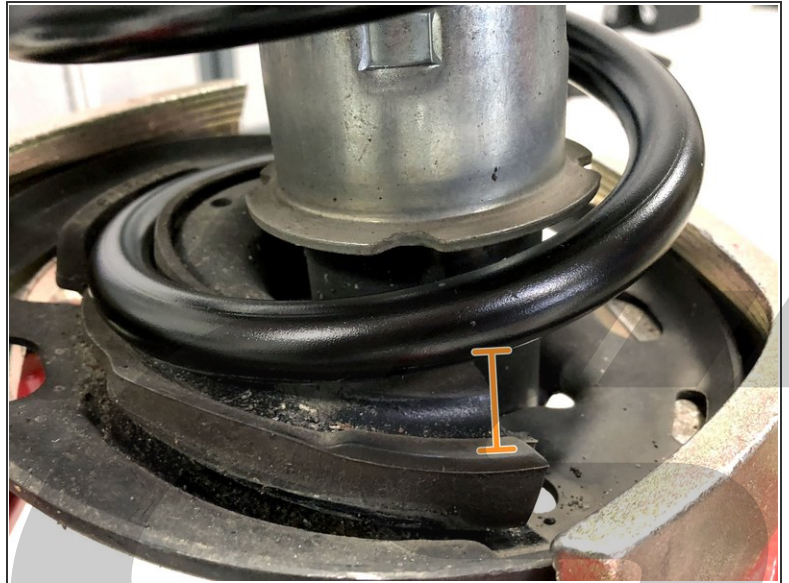

- Reinstall the black plastic cover removed in step 9.
- It is normal for there to be a gap between the spring and the lower spring seat about a 1/2 coil from the end of the spring as shown.



## Step 18 — Front Suspension Reassembly Part 1

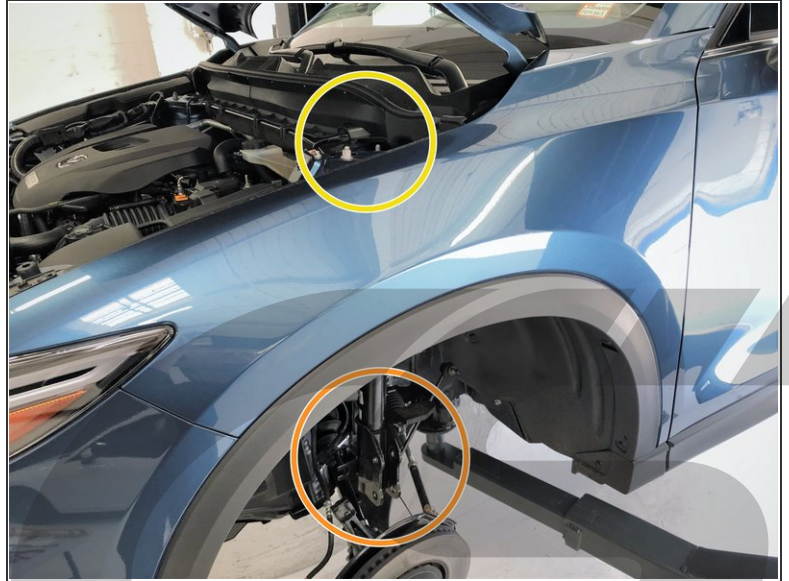
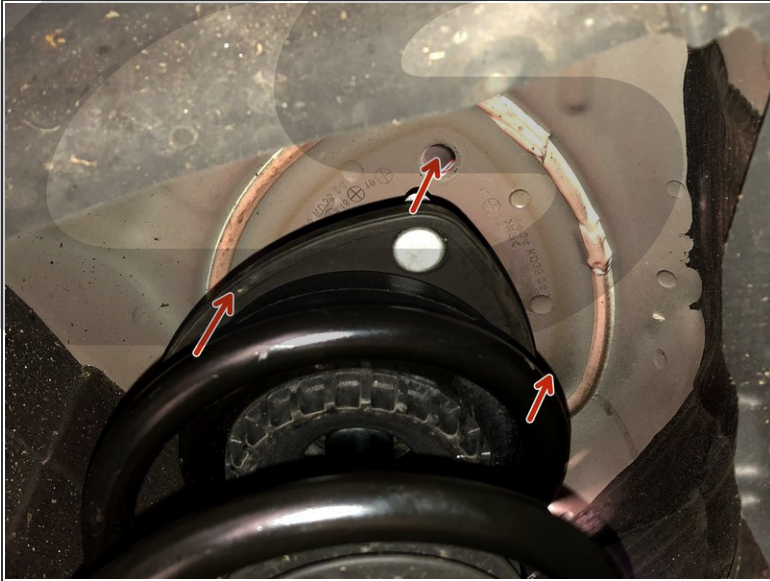

- Lift the assembled strut back into place.
- Look in the fender to align the three top strut mounting studs to the three holes in the shock tower.
- Lightly push the strut through these three holes.
- Hold the bottom of the strut with one hand.
- Use the other hand to loosely tighten the qty(3) 14mm nuts removed in step 8.

## Step 19 — Front Suspension Reassembly Part 2

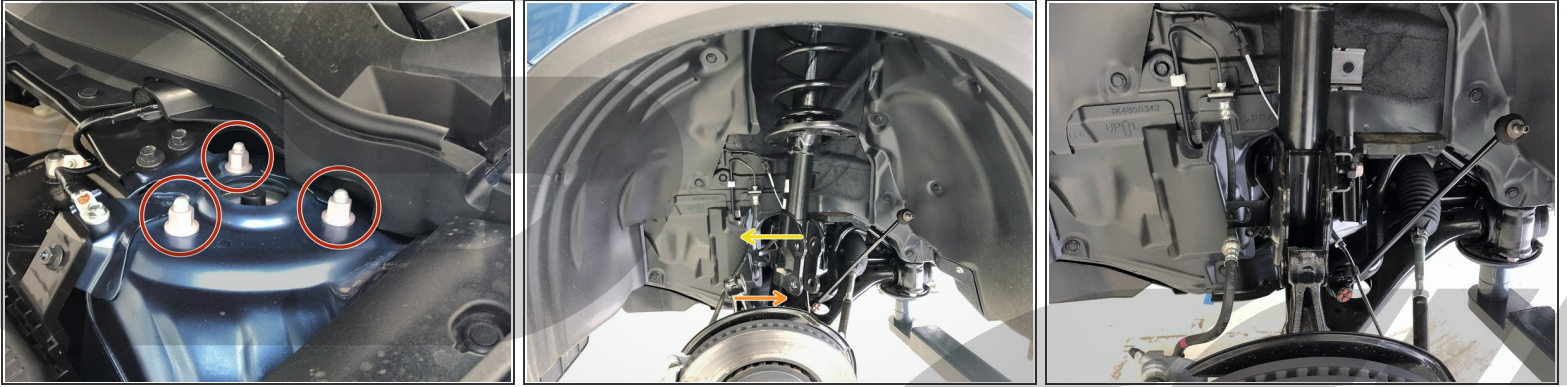

- Tighten the three upper strut nuts to **37-43 ft-lbs.** using a 14mm socket.
- Your strut may be misaligned to the knuckle. This is normal. Shown in the second image.
- Lift the knuckle up so the mounting holes are horizontal.
- Rotate the strut to match the angle of the knuckle. Shown in the third image.

## Step 20 — Front Suspension Reassembly Part 3

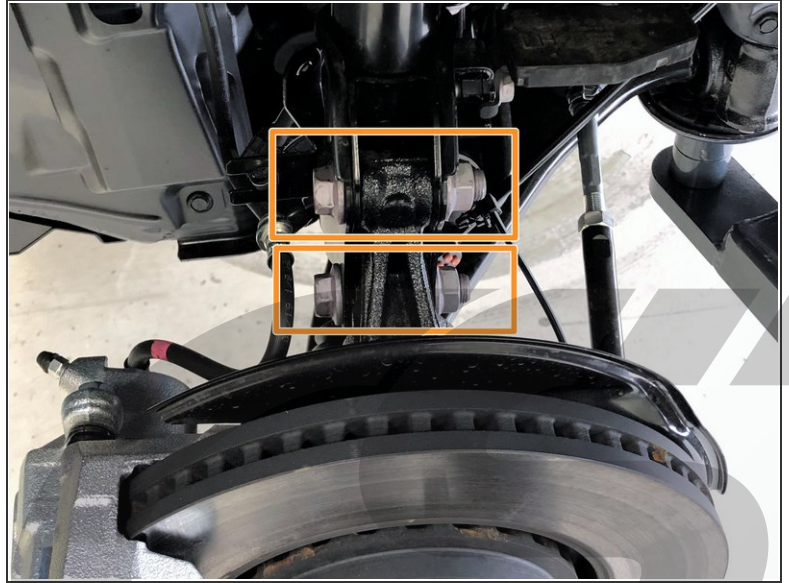
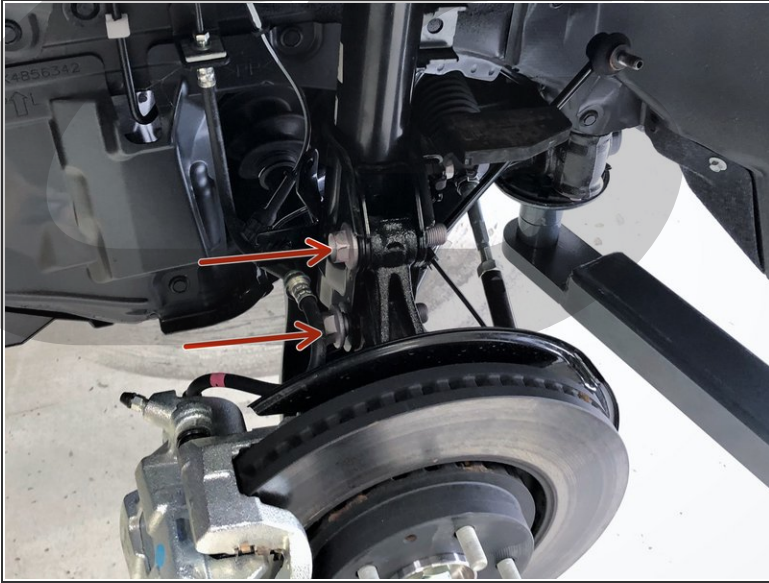

- Lift the knuckle to align the mounting holes with the mounting holes on the bottom of the strut.
- Insert the two large bolts removed in step 7.
- ⓘ The knuckle and/or strut may need to be shifted around to allow the bolts to be inserted.
- Thread on the large nuts removed in step 7.
- Tighten the lower strut mounting bolts to **164-180ft-lbs.** using a 21mm wrench on the bolt and a 23mm socket & torque wrench on the nut.

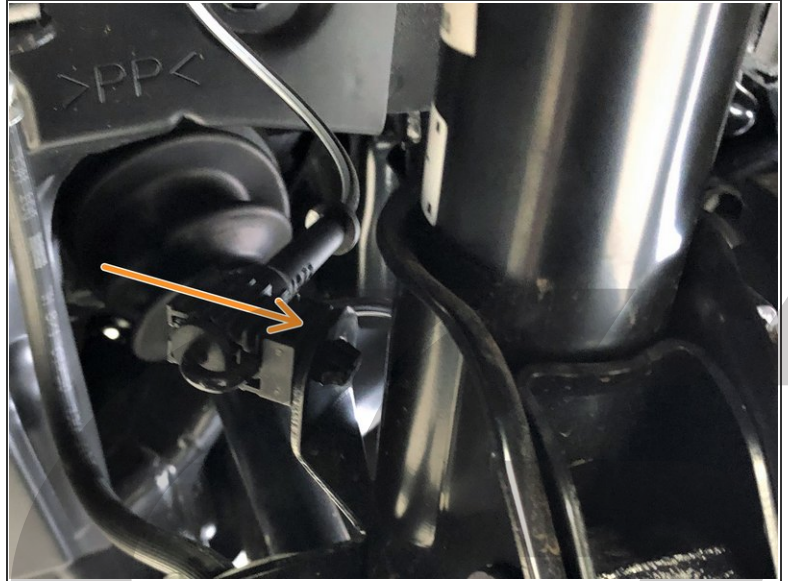
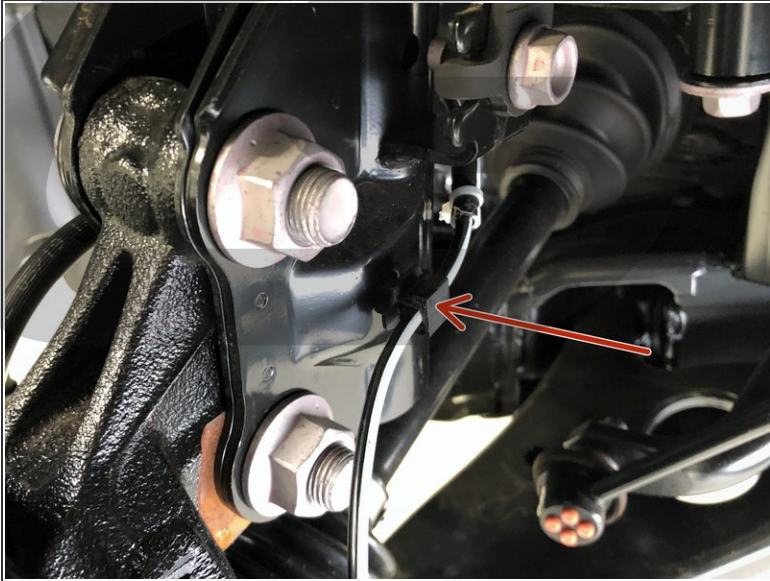
**Step 21 — Front Suspension Reassembly Part 4**

- Reconnect the rearward ABS wiring by pushing the clip into the hole it was removed from in step 6.
- Reconnect the forward ABS wiring by pushing the clip into the slot it was removed from in step 6.

## Step 22 — Front Suspension Reassembly Part 5

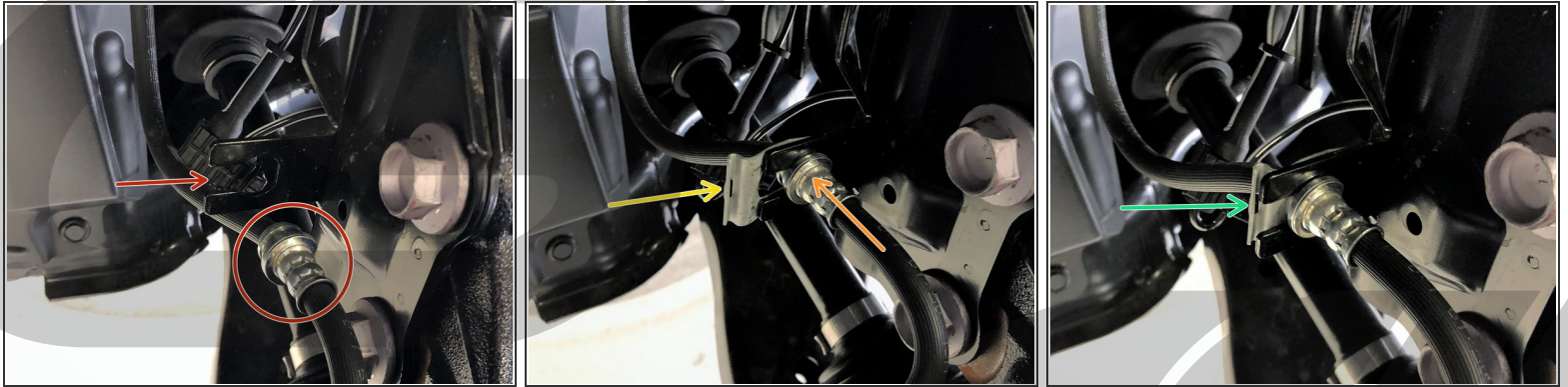

- Insert the brake line into the bracket you removed it from earlier.
  - Push forward on the line slightly to ensure it is fully seated.
  - While pushing forward, insert the brake line retainer clip that was removed in step 5.
  - Push the brake line retainer clip inward until the brake line is secured.
- ⓘ You may need to tap the retainer clip gently with a hammer in order to get it fully installed.

## Step 23 — Front Suspension Reassembly Part 6

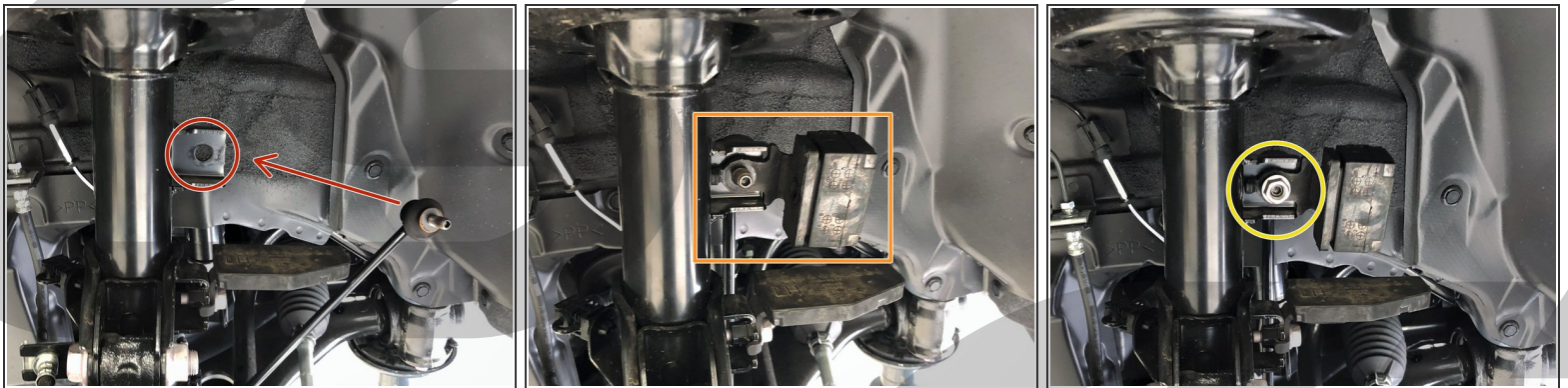

- Insert the front sway bar end link into the mounting point on the front strut.
  - Replace the rubber noise isolator removed in step 4.
  - Reinstall the end link nut removed in step 4.
  - Tighten the end link nut to **34-40ft-lbs.** using a 14mm socket.
- ⓘ If the nut is spinning without tightening, see the method shown in step 4.

## Step 24 — Front Suspension Wrap Up



- Repeat steps 2-23 for the right side of the vehicle.
- Reinstall both front wheels. Using a 21mm socket on each of the 5 lug nuts.
- Lower the front of the car down off the jack stands.
- Torque the lug nuts in a star pattern to **80-90ft-lbs.**

## Step 25 — Lifting the Car & Removing the Rear Wheel



- Lifting up the rear of the car using the hydraulic jack and jack stands.
- ⚠ Be sure to reference your owners manual for jack points and the jack manufacturer's instructions for proper practices.
- Remove the left side rear wheel from the vehicle using the 1/2" drive breaker bar or impact gun and 21mm socket.
- ⓘ A different socket may be required if you have aftermarket or locking lug nuts.

## Step 26 — Rear Suspension Component Identification

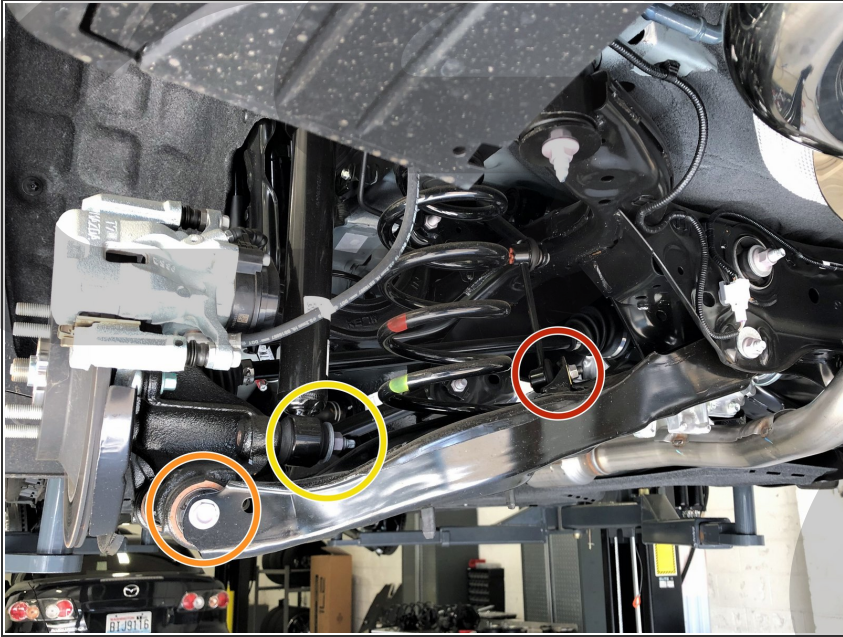

- This image serves as a location reference for components referenced in the following steps.
- Rear sway bar end link.
- Lower control arm bolt.
- Lower shock mount.

## Step 27 — Rear Suspension Disassembly Part 1



- Locate the rear sway bar end link.
- Using a 14mm socket and ratchet, remove the end link nut.
- ⓘ If the nut is spinning without loosening, use a 5mm Allen wrench and 14mm wrench as shown in step 4.
- Push the rear sway bar end link out of the mount on the lower control arm and out of the way.



## Step 28 — Rear Suspension Disassembly Part 2

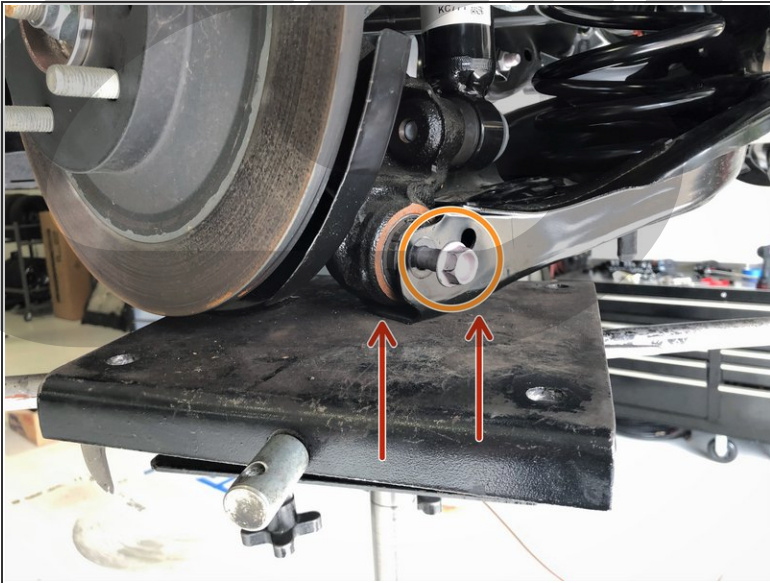

- Place the hydraulic jack directly below the lower control arm bolt and apply a small amount of upward pressure.
- ⚠ Ensure your jack is secure and is not contacting the brake rotor or other brake components.
- ⓘ This step ensures the spring will not fly out suddenly when removing it from the vehicle.
- Using a 17mm socket with a breaker bar or impact gun, loosen the lower control arm bolt.
- Then remove the lower control arm bolt.
- ⓘ This bolt will need to be threaded out almost entirely before it can be removed.

## Step 29 — Rear Suspension Disassembly Part 3

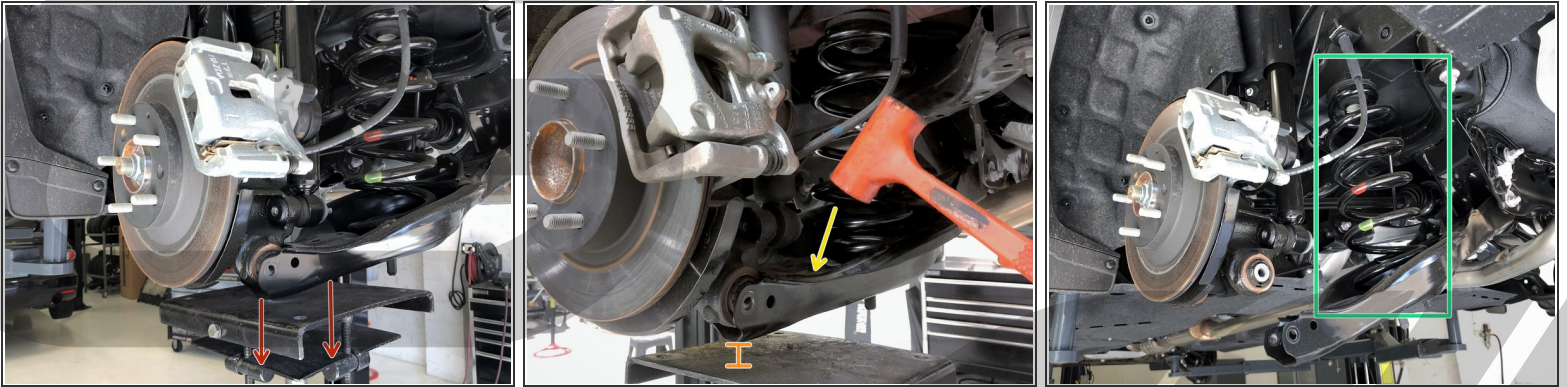

- Slowly lower the jack to release the tension on the spring.
- If the control arm gets stuck on its mounting location and is not lowering with the jack (shown in image 2) stop the jack **immediately**.
  - Then, using a dead blow hammer or rubber mallet, give the control arm a light tap until it reestablishes connection with the jack.
- Lower the jack until the spring no longer has any tension as shown.

## Step 30 — Rear Suspension Disassembly Part 4

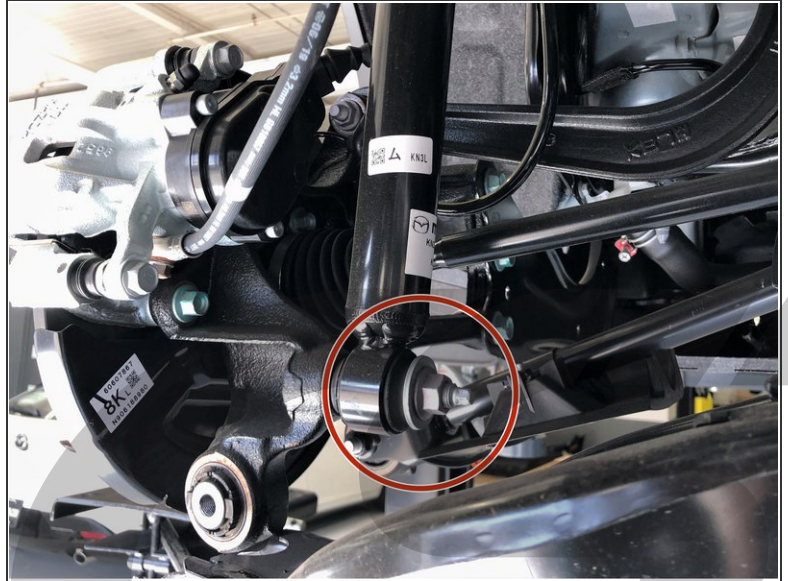

- Move the jack out of the way and remove the spring from the vehicle.
- Locate lower shock mount.
- Using a 19mm socket with a breaker bar or impact gun, remove the lower shock mounting nut and washer.

## Step 31 — Rear Suspension Disassembly Part 5

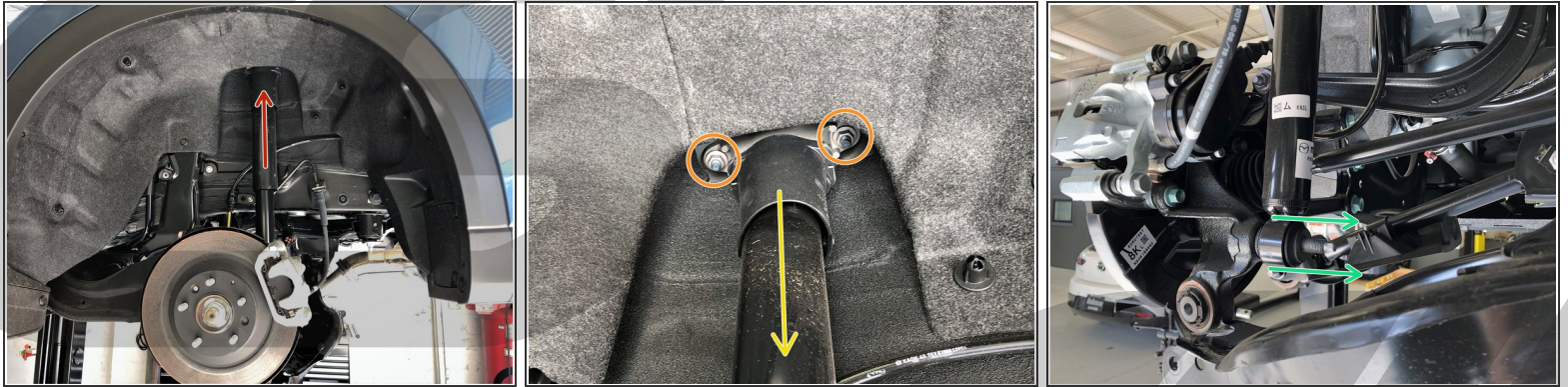

- Trace the shock body up into the fender to locate the two upper shock mounts.
- Remove the upper shock mounting nuts with a 14mm socket and ratchet.
- Compress the shock by hand.
- Push the shock off the lower mounting stud.
  - ⓘ The shocks can get stuck on the mounting stud. You may need to lightly tap the shock body with a dead blow hammer to free it from the lower mounting stud.
- Remove the shock from the vehicle.

## Step 32 — Rear Shock Disassembly

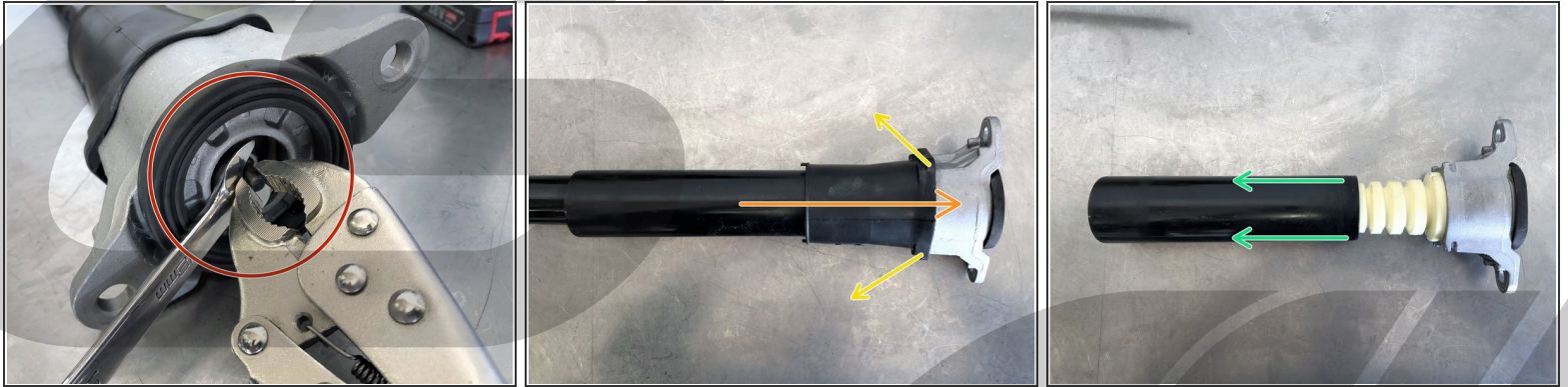

- Using a 12mm wrench and small vice grip, loosen the top shock nut.
  - ⓘ The wrench will be used to loosen the nut, the vice grip is just there to prevent the shock from rotating.
- Remove the rear shock top hat.
- Pull the rubber bump stop cover in the directions shown to free it from the top hat. Then remove the bump stop cover.
- Remove the black plastic dust shield from the bump stop.
  - ⓘ The dust shields can be difficult to remove and may require some force. Be sure you do not damage any components as they will be reused.

### Step 33 — Cutting the Rear Bump Stop

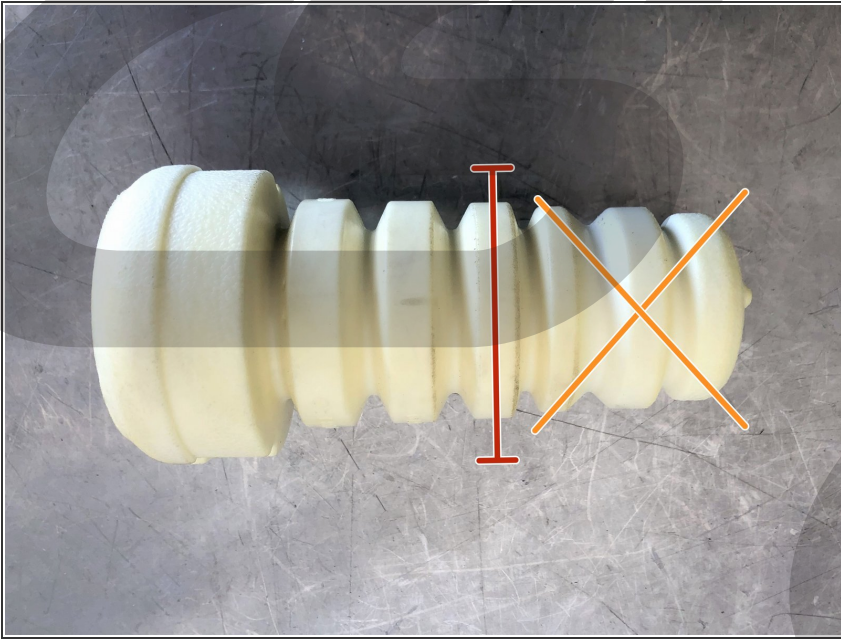

- ① In order to deliver the best ride quality, the bump stop must be trimmed. This ensures the same amount of travel before the bump stop is hit at the lower ride height.
- ① Bump stop shown removed from the top hat for clarity.
  - Draw a line in the middle of the fourth bulge all around the bump stop.
  - Cut the bump stop using a razor knife along this line.
  - Discard the lower section of the bump stop.
- ① After cutting, the bump stop should be about 76mm long.

## Step 34 — Rear Shock Reassembly

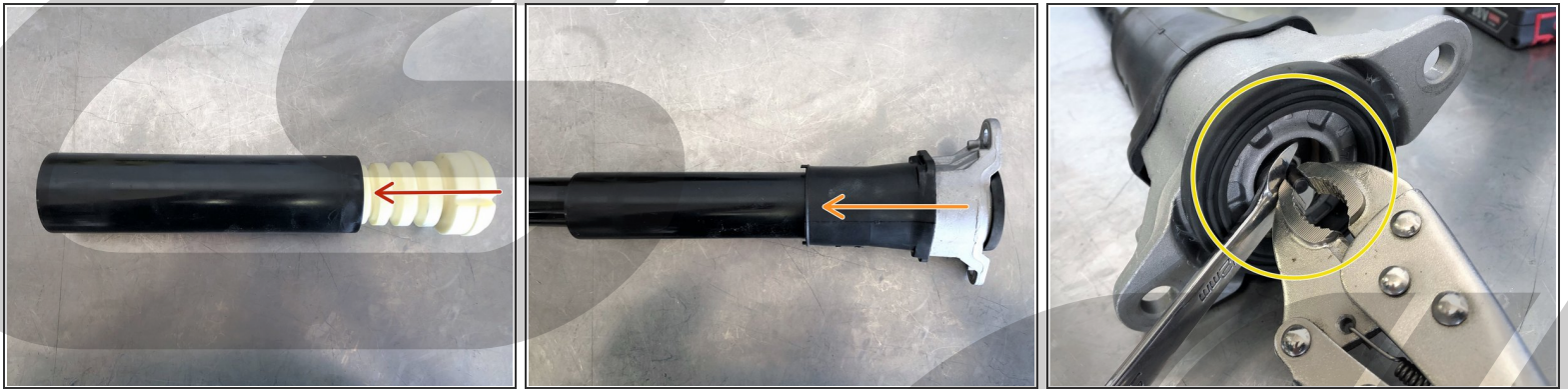

- Insert the now shorter bump stop into the dust shield. It will slide on with some effort.
- Reinstall the rubber bump stop cover.
- Replace the shock top hat, bump stop, bump stop cover, and dust shield assembly on the shock.
- Tighten the shock top nut to **18-22ft-lbs.** using the method shown in step 32.

## Step 35 — Rear Suspension Reassembly Part 1

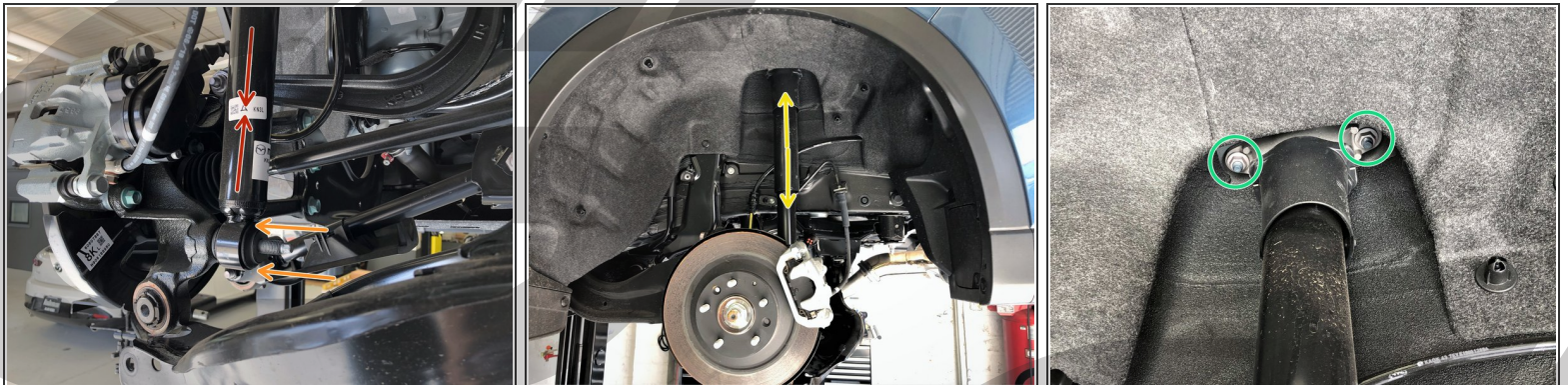

- Compress the shock by hand.
- Insert the shock back into position.
- Insert the large stud into the lower shock mount.
- Let the shock expand back to its original length.
- Align the top hat holes with the studs on the chassis.

## Step 36 — Rear Suspension Reassembly Part 2



- Reinstall and tighten the 14mm upper shock mounting nuts to **26-30ft-lbs.**
- Reinstall the lower shock mounting washer. It will align with the grooves in the lower shock mounting stud.
- Reinstall and tighten the 19mm lower shock mounting nut to **62-73ft-lbs.**



## Step 37 — Rear Suspension Reassembly Part 3



- Inspect the spring perch inside the rear lower control arm.
  - The first image shows the spring perch misplaced and not fully seated.
  - The second image shows the spring perch correctly positioned and fully seated.
  - Ensure your lower spring perch is fully seated and positioned correctly.
  - Swap the upper spring perch from the OEM spring to the rear CorkSport lowering spring.
  - For easy identification, the top of the CS spring is smaller in diameter and will fit snugly on the OEM upper spring perch.
- ⚠ There is a sticker labeling the spring for use at CS. These stickers are sometimes placed upside-down. Do not use this sticker to orient the spring.
- ℹ If desired, the stickers can be removed with the help of some brake parts cleaner or acetone.

### Step 38 — Rear Suspension Reassembly Part 4



- Insert the CorkSport Lowering Spring into the rear lower control arm.
- Rotate the CS spring until the end is touching the stop in the lower spring perch.
  - Image 2 shows the spring not fully seated on the stop of the lower spring perch.
  - Image 3 shows the spring fully seated.

### Step 39 — Rear Suspension Reassembly Part 5



- Place the hydraulic jack underneath the rear lower control arm like in step 28.
- Slowly raise the hydraulic jack to locate the spring and the lower control arm bolt holes.
  - As you raise the jack, ensure the upper spring seat fits over the small protrusion in the chassis.
  - Image 3 shows the upper spring seat correctly positioned.

## Step 40 — Rear Suspension Reassembly Part 6



- Lift the lower control arm up until the mounting holes align with the holes in the knuckle.
- Once the holes are nearly aligned, use a large screwdriver or tapered pry bar to better align the holes.
- When able, insert the 17mm lower control arm bolt.
- ⓘ Using a dead blow hammer or rubber mallet helps install the bolt as far as possible before the next step.
- ⓘ The bolt typically does not line up with the nut on the other side of the control arm. This is normal.

## Step 41 — Rear Suspension Reassembly Part 7

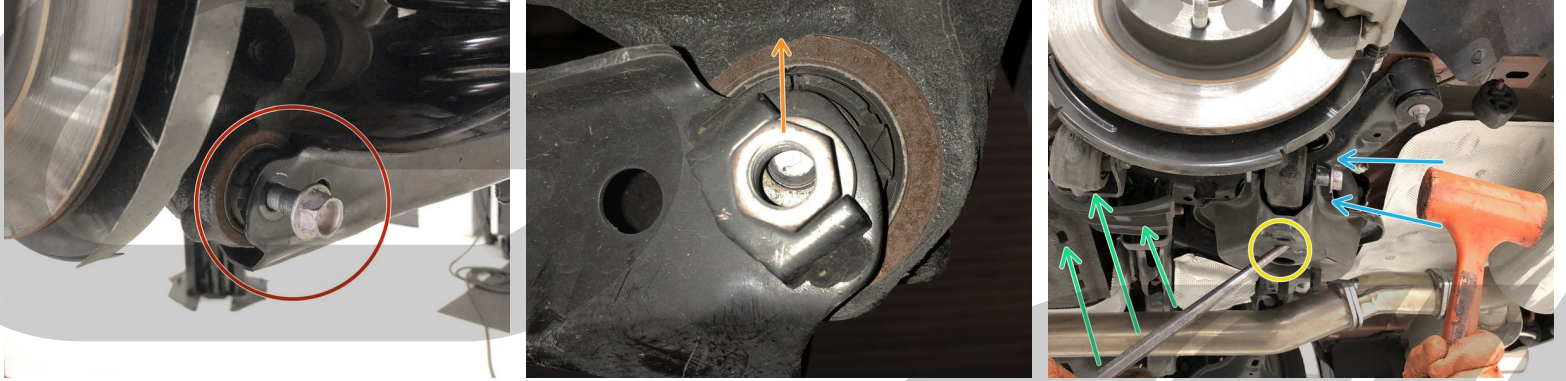

- ⚠** Do not perform the next step until you are confident the 17mm lower control arm bolt is secure.
- Once the 17mm lower control arm bolt is secure, lower the hydraulic jack out of the way.
  - To align the lower control arm bolt with the nut it tightens against, the control arm will need to be twisted.
  - Insert a large screwdriver or tapered pry bar into a hole in the bottom of the lower control arm.
  - Pry in the direction shown in image 3 until the lower control arm bolt aligns with the lower control arm nut.
  - Then using a dead blow hammer or rubber mallet, tap the lower control arm bolt until it rests against the nut.

## Step 42 — Rear Suspension Reassembly Part 8

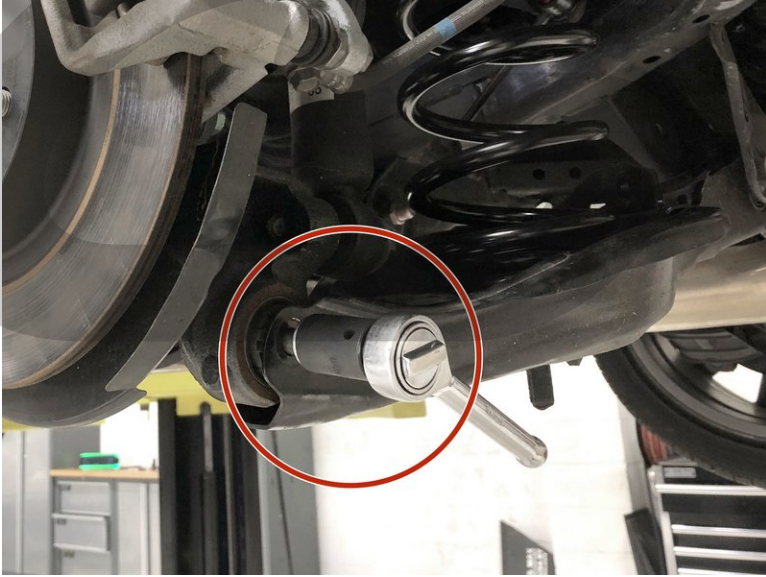

- Once you are confident the lower control arm bolt is in the lower control arm nut, thread it in by hand.
  - If the bolt does not thread by hand, a 17mm wrench or socket can be used **carefully**.
- ⚠ If the bolt is not threading into the nut easily, do not force it as it can easily cross thread.
- Once the 17mm lower control arm bolt is threaded into the nut 2-3 turns, tighten it fully to **64-77ft-lbs**.

## Step 43 — Rear Suspension Reassembly Part 9

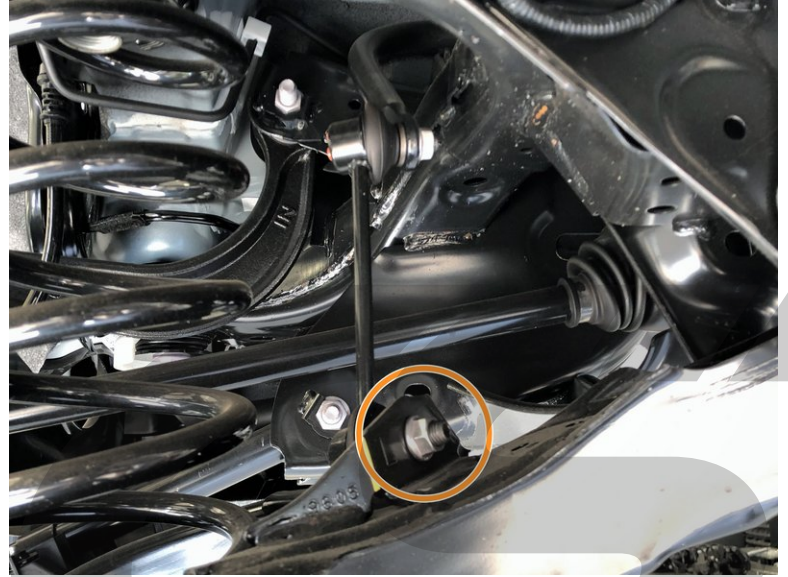

- Locate the rear swaybar end link.
- Reinsert the threaded end through the hole in the lower control arm.
- Thread on the 14mm nut removed in step 27.
- Tighten to **34-40 ft-lbs.**
- ⓘ If the nut is spinning without tightening, use a 14mm wrench and 5mm Allen wrench/socket as shown in step 4.

## Step 44 — Rear Suspension Wrap Up



- Repeat steps 25-43 for the right side of the vehicle.
- Reinstall both rear wheels. Using a 21mm socket on each of the 5 lug nuts.
- Lower the rear of the car down off the jack stands.
- Torque the lug nuts in a star pattern to **80-90ft-lbs.**

## Step 45 — Installation Complete



- This completes your installation of the CorkSport Performance Lowering Springs!
- ⓘ Listen for any strange noises upon first drive. If any are present, inspect the suspension.
- Contact us with any questions or concerns at [sales@corksport.com](mailto:sales@corksport.com) or (360) 260-2675.
- Please leave a review here: <https://corksport.com/2017-mazda-cx-5-lo...>
- Share your experience using #CorkSport on Instagram, Facebook, and Twitter.

